

E6

Manual (1.0 EN)



Symbols on the equipment

Please refer to the information in the operating manual.

WARNING!
Dangerous voltage!

Contents

Safety precautions	3
Information regarding use of loudspeakers.....	3
E6	4
Connections.....	5
Operation with D6 or D12.....	5
Operation with E-PAC.....	6
Dispersion characteristics.....	7
Altering the HF horn dispersion.....	7
Technical specifications.....	8
Manufacturer's declarations	9
EU conformity of loudspeakers (CE symbol).....	9
WEEE Declaration (Disposal).....	9

General Information

E6 Manual

Version 1.0 EN, 03/2010, D2606.EN .01

Copyright © 2010 by d&b audiotechnik GmbH; all rights reserved.

Keep this manual with the product or in a safe place so that it is available for future reference.

When reselling this product, hand over this manual to the new customer.

If you supply d&b products, please draw the attention of your customers to this manual. Enclose the relevant manuals with the systems. If you require additional manuals for this purpose, you can order them from d&b.

d&b audiotechnik GmbH
Eugen-Adolf-Strasse 134, D-71522 Backnang, Germany
Telephone +49-7191-9669-0, Fax +49-7191-95 00 00
E-mail: docadmin@dbaudio.com, Internet: www.dbaudio.com

Safety precautions



WARNING!

Information regarding use of loudspeakers

Never stand in the immediate vicinity of loudspeakers driven at a high level. Professional loudspeaker systems are capable of causing a sound pressure level detrimental to human health. Seemingly non-critical sound levels (from approx. 95 dB SPL) can cause hearing damage if people are exposed to it over a long period.

In order to prevent accidents when deploying loudspeakers on the ground or when flown, please take note of the following:

When setting up the loudspeakers or loudspeaker stands, make sure they are standing on a firm surface. If you place several systems on top of one another, use straps to secure them against movement.

Only use accessories which have been tested and approved by d&b for assembly and mobile deployment. Pay attention to the correct application and maximum load capacity of the accessories as detailed in our specific "Mounting instructions" or in our "Flying system and Rigging manuals".

Ensure that all additional hardware, fixings and fasteners used for installation or mobile deployment are of an appropriate size and load safety factor. Pay attention to the manufacturers' instructions and to the relevant safety guidelines.

Regularly check the loudspeaker housings and accessories for visible signs of wear and tear, and replace them when necessary.

Regularly check all load bearing bolts in the mounting devices.

CAUTION!

Loudspeakers produce a static magnetic field even if they are not connected or are not in use. Therefore make sure when erecting and transporting loudspeakers that they are nowhere near equipment and objects which may be impaired or damaged by an external magnetic field. Generally speaking, a distance of 0.5 m (1.5 ft) from magnetic data carriers (floppy disks, audio and video tapes, bank cards, etc.) is sufficient; a distance of more than 1 m (3 ft) may be necessary with computer and video monitors.

E6

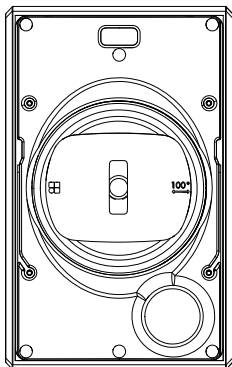

Fig. 1: E6 loudspeaker

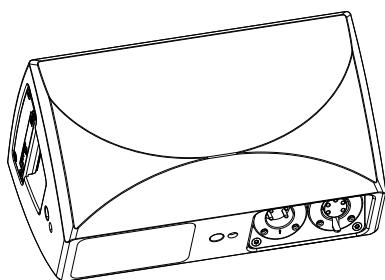

Fig. 2: E6 stage monitor setup

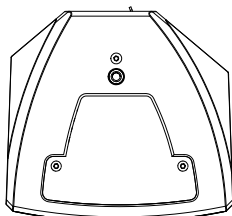

Fig. 3: E6 SC/WR versions top view

The E6 is a high performance multipurpose loudspeaker employing an integrated 6.5"/1" exit coaxial driver design with neodymium magnet and constant directivity horn loading. The horn with its 100° x 55° (hor. x vert.) dispersion pattern can easily be rotated through 90° providing a 55° x 100° pattern without the use of tools.

The E6 is a two-way design with a built-in passive crossover network. Its frequency response extends from 85 Hz to 20 kHz.

The E6 enclosure is injection-molded from polyamide with an impact and weather resistant black paint finish. The cabinet shape allows use either in a vertical or horizontal orientation as well as deployment as a stage monitor.

The front of the loudspeaker cabinet is protected by a rigid metal grill in front of an acoustically transparent fabric. The grill can easily be removed without tools to modify the horn orientation.

The cabinet incorporates a handle and four M8 threaded inserts to connect to different rigging accessories like Z5377 E6 Flying bracket, Z5378 E6 Horizontal bracket or a safety wire.

The connector panel of the E6 cabinet is recessed and tilted to allow deployment as a stage monitor. With the panel on the right hand side, the cabinet is oriented correctly.

NOTICE: Only operate E6 loudspeakers with a correctly configured d&b amplifier, otherwise there is a risk of damaging the loudspeaker components.

E6 cabinet options

The special color (SC) version of the cabinet is available in all colors of the RAL color table. It comes without the handle. The respective opening of the cabinet is covered by a plate in cabinet color. The connector type is NL4.

The weather resistant (WR) version is available in black only. It also comes without the handle. It is equipped with a fixed input cable (5 m / 16.4 ft, type H-07-RN-F 2 x 2.5 mm²/AWG 13).

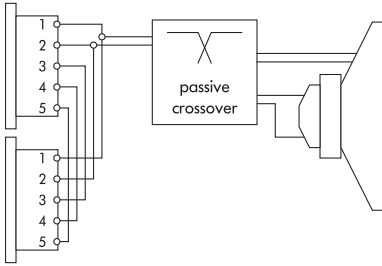

Fig. 4: Connector wiring

Connections

The E6 cabinet is fitted with a pair of EP5 connectors. All five pins of both connectors are wired in parallel. The E6 uses the pin assignments 1/2. Pins 3/4 and 5 are designated to active subwoofers, where pin 5 is used for SenseDrive (only available when using a D12 amplifier and 5-wire cabling). Using the male connector as the input, the female connector allows for direct connection to additional loudspeakers.

The E6 can be supplied with NL4 connectors as an option.

Pin equivalents of EP5 and NL4 connectors and the fixed cable option are listed in the table below.

EP5	1	2	3	4	5
NL4	1+	1-	2+	2-	n.a.
Fixed cable (PG)	Brown (+)	Blue (-)			

Operation with D6 or D12

Select the controller setup E6.

On the D12 amplifier it is available in "Dual Channel" and "Mix TOP/SUB" mode. For combinations with active subwoofers fed by a single 4/5-wire cable "Mix TOP/SUB" mode must be selected.

Up to a total of five E6 loudspeakers can be driven by each channel of the D6 or D12 amplifiers.

Controller settings

For acoustic adjustment the functions CUT, HFA and CPL can be selected.

CUT circuit

Set to CUT, the E6 low frequency level is reduced. The E6 is now configured for use with E12X-SUB or E15X-SUB in active mode or other d&b active subwoofers.

HFA circuit

In HFA mode (High Frequency Attenuation), the HF response of the E6 system is rolled off. The HFA circuit provides a natural, balanced frequency response when a unit is placed close to listeners in near field or delay use.

High frequency attenuation begins gradually at 1 kHz, dropping by approximately 3 dB at 10 kHz. This roll-off mimics the decline in frequency response experienced when listening to a system from a distance in a typically reverberant room or auditorium.

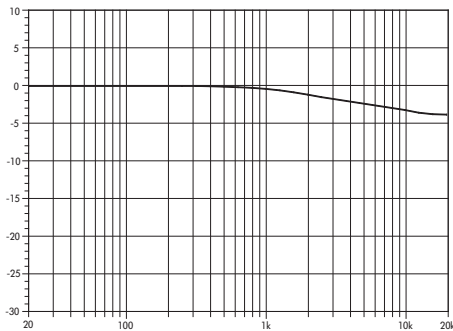

Fig. 5: Frequency response correction of HFA circuit

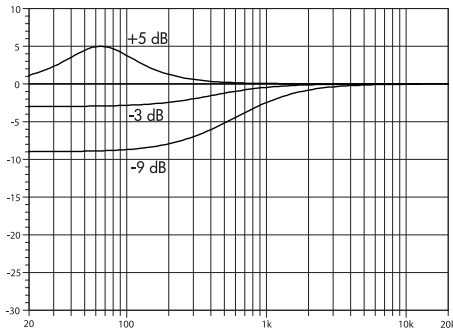

Fig. 6: Frequency response correction of CPL circuit

CPL circuit

The CPL (Coupling) circuit compensates for coupling effects when building closely coupled arrays or when the cabinet is used as a stage monitor. CPL begins gradually at 1 kHz, with maximum attenuation below 250 Hz, providing a balanced frequency response when E6 cabinets are used in arrays of two or more. The function of the CPL circuit is shown in the diagram opposite and can be set in dB attenuation values between -9 and 0, or a positive CPL value which creates an adjustable low frequency boost around 65 Hz (0 to +5 dB).

Operation with E-PAC

Selecting E6 mode enables the E-PAC to drive up to three E6 loudspeakers. LO IMP mode configures the E-PAC to drive a maximum of five E6 loudspeakers with a 6 dB reduction in input level to the loudspeakers.

For acoustic adjustment the functions CUT and HFA can be selected. The characteristics of the CUT and HFA settings are explained in the previous section "Operation with D6 or D12 - Controller settings".

Dispersion characteristics

The graphs below show dispersion angle over frequency of a single E6 cabinet plotted using lines of equal sound pressure (isobars) at -6 dB and -12 dB.

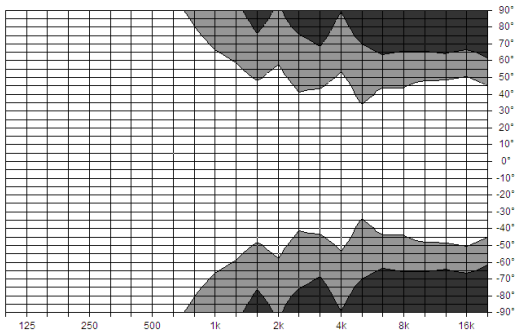

Fig. 7: Isobar diagram E6 horizontal, standard setup

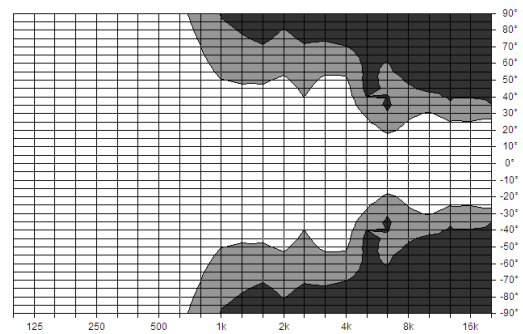
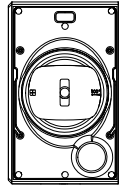

Fig. 8: Isobar diagram E6 vertical, standard setup

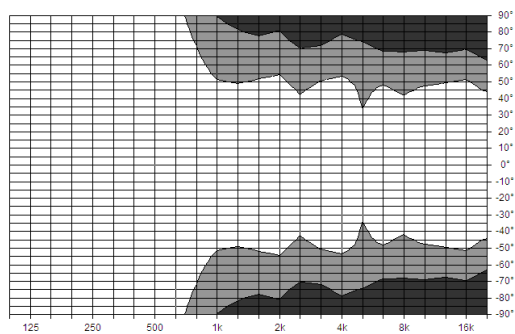

Fig. 9: Isobar diagram E6 horizontal, horizontal setup with the horn rotated

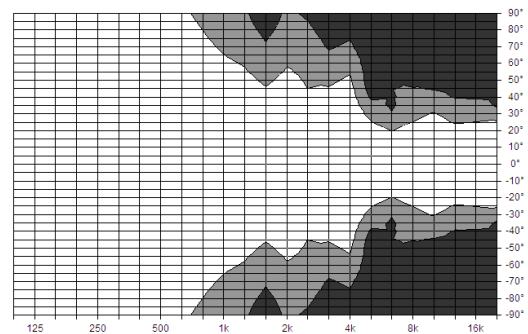
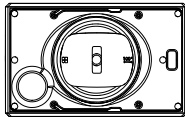

Fig. 10: Isobar diagram E6 vertical, horizontal setup with the horn rotated

Altering the HF horn dispersion

The HF horn can be rotated through 90° within the coaxial driver assembly. There are no tools required as the grill is attached to the baffle by magnets. It is secured by an additional safety wire.

The grill can be accessed through an opening in the top handle of the cabinet.

- Remove the grill.
- Take the horn at its outer edges and turn it until it snaps into the desired direction.
- Relocate and fix the front grill.
Make sure the safety wire slips into the recess between baffle and cabinet body.

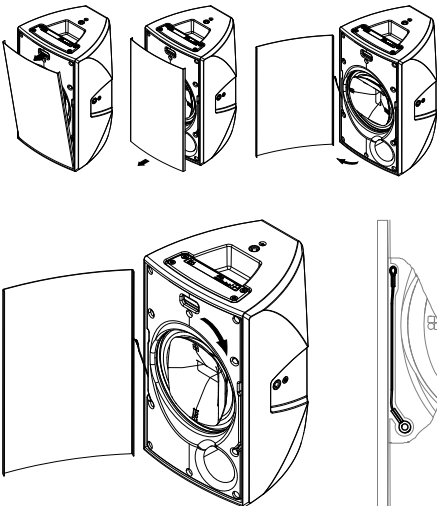

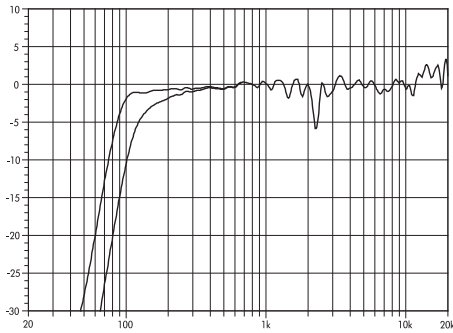

Fig. 11: E6 frequency response, standard and CUT settings

Technical specifications

E6 system data

Frequency response (-5 dB standard)	85 Hz ... 20 kHz
Frequency response (-5 dB CUT mode)	120 Hz ... 20 kHz
Max. sound pressure (1 m, free field) E6 with D12	123 dB
Max. sound pressure (1 m, free field) E6 with D6 or E-PAC	120 dB
	(SPLmax peak, pink noise test signal with crest factor of 4)
Input level (100 dB-SPL/1 m)	-11 dBu

E6 loudspeaker

Nominal impedance	20 ohms
Power handling capacity (RMS / peak 10 ms)	150/800 W
Nominal dispersion angle (hor. x vert.)	100° x 55°
Components	6.5" driver with neodymium magnet
	coaxial 1" exit compression driver with 1.75" coil and rotatable CD horn
	Passive crossover network
Connections	2 x EP5
	Optional and SC option: 2 x NL4
	WR option: Fixed cable 5 m (16.4 ft) (H-07-RN-F 2 x 2.5 mm ² /AWG 13)
Pin assignments	EP5: 1/2
	NL4: 1+/1-
	Fixed cable: Brown + / Blue -
Weight	5.0 kg (11 lb)

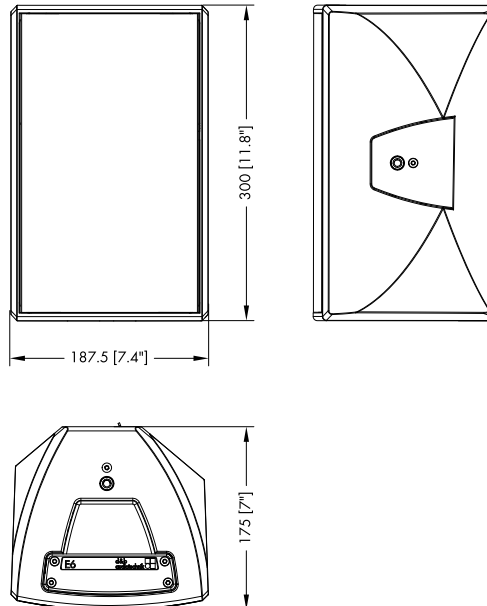

Fig. 12: E6 cabinet dimensions in mm [inch]

Manufacturer's declarations



EU conformity of loudspeakers (CE symbol)

This declaration applies to

E6 loudspeaker, Z0350

manufactured by d&b audiotechnik GmbH.

All production versions of this type are included, provided they correspond to the original technical version and have not been subject to any later design or electromechanical modifications.

We herewith declare that said products are in conformity with the provisions of the respective EC directives including all applicable amendments.

A detailed declaration is available on request and can be ordered from d&b or downloaded from the d&b website at www.dbaudio.com.

WEEE Declaration (Disposal)

Electrical and electronic equipment must be disposed of separately from normal waste at the end of its operational lifetime.

Please dispose of this product according to the respective national regulations or contractual agreements. If there are any further questions concerning the disposal of this product please contact d&b audiotechnik.

