

**MULTIVIEWER (MVR) MENU**

**M1: Select MVR Sources** - From the dropdown menus select the Inputs, Backgrounds and Destinations you want to view and drop them into a Multiviewer Outputs. Overlapping is not allowed. A MVR source can be used only once. A maximum total of 64 windows can be used.

**M2: Auto Layout Input** - Click on this button to automatically place all Inputs into the selected output.

**M3: Adjust Window** - Adjust the size, position and the color parameters associate with each window. Repeat for all Inputs and save.

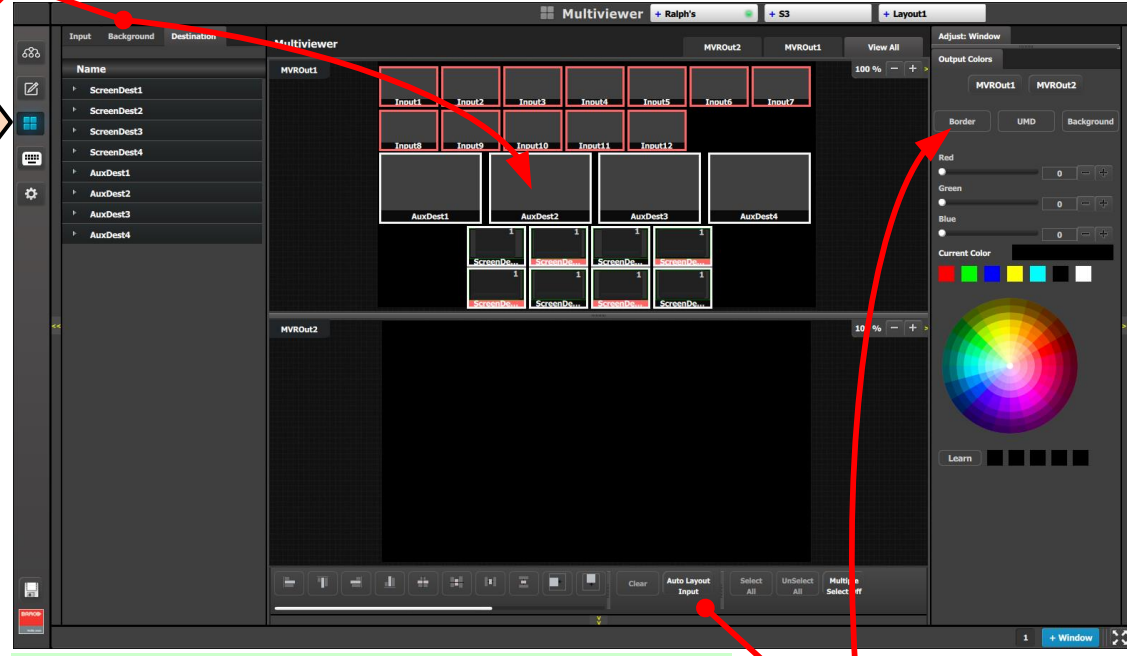

For release 2 only outputs 1 & 2 are active; Clocks will be available in post software release 2.

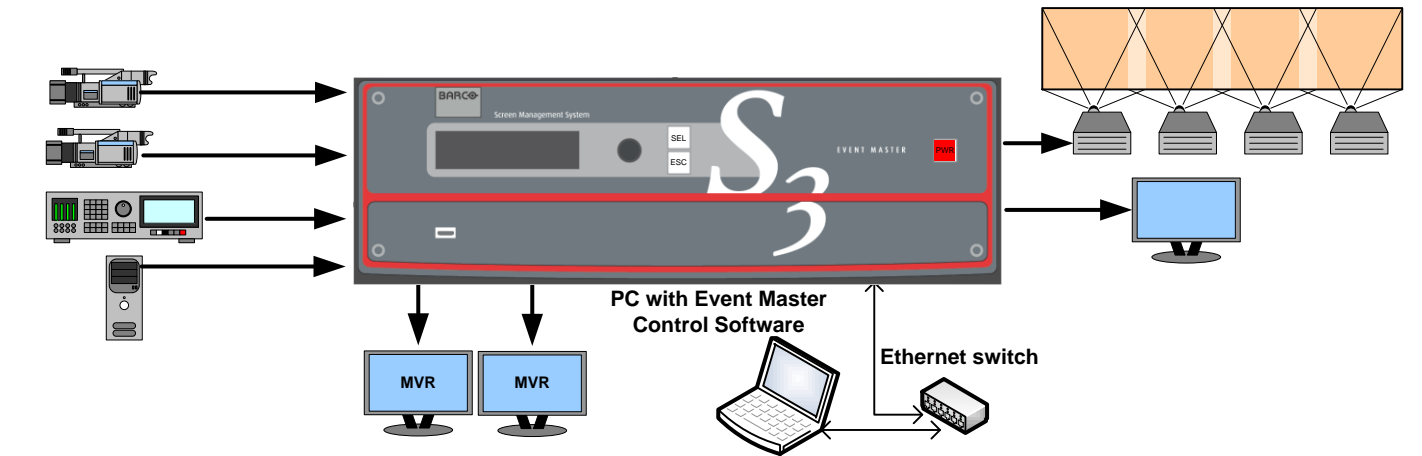

1. Ensure that the unit is physically secured in a rack or is placed on a flat surface with stable support. If the unit is installed in a rack, it is mandatory that the rear brackets are also installed.
  2. Connect all sources, displays and peripherals to the S3-4K according to your event's requirements. If power redundancy is desired, connect power to both power plugs.
  3. Connect to a computer that has the Event Master control software installed, via an Ethernet cable. A switch is optional if additional devices will be connected.
  4. Power up the S3-4K, the PC, all monitors and peripherals.
  5. Verify that no errors messages appear on the S3-4K front panel.
  6. After the S3-4K boots up, run the Event Master control software and follow the sequence of instructions listed in the Quick Start Guide to complete the system setup and configuration.
- Always refer to the User's Guide for detailed system specifications, descriptions and operation instructions.

**SETTINGS MENU**

**S1: Options** - From the dropdown menu select the desired language. Click on the boxes to select system wide user preferences such as Layer positioning.

**S2: Tools** - Allows users to perform Backup and Restore operations or download the latest software from the Barco website

**S3: Dashboard** - Provides status information regarding the cards and other system diagnostic information.

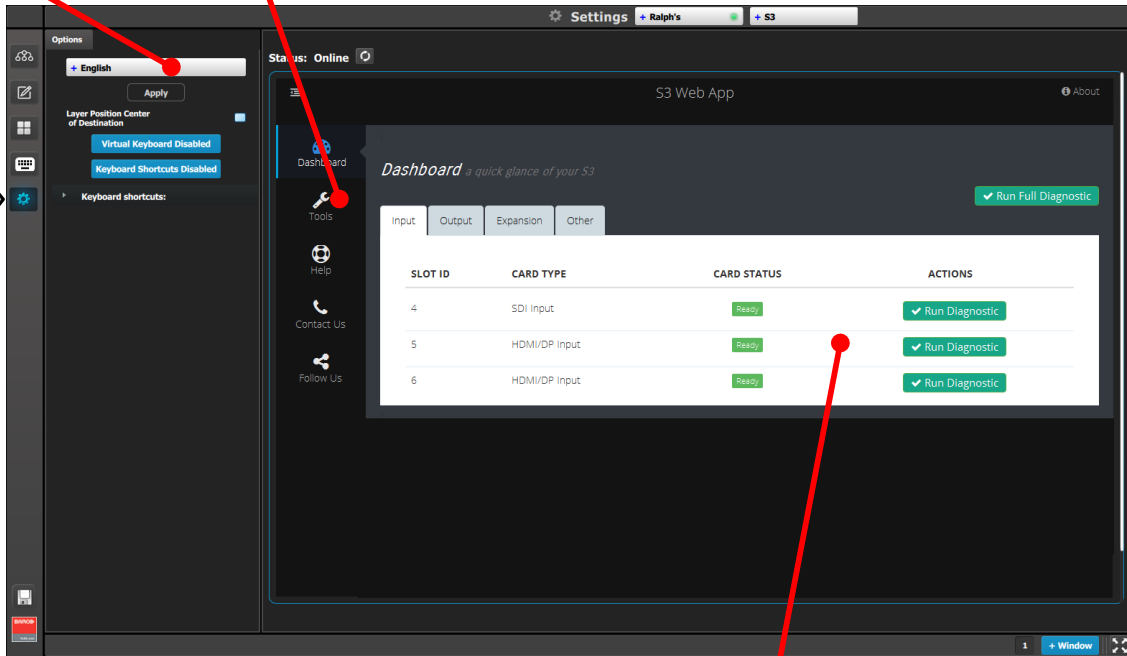

- For the latest version of the User's Guide and the Quick Start Guide, visit [www.barco.com](http://www.barco.com).  
 - Any item contained in this document may change without notice.

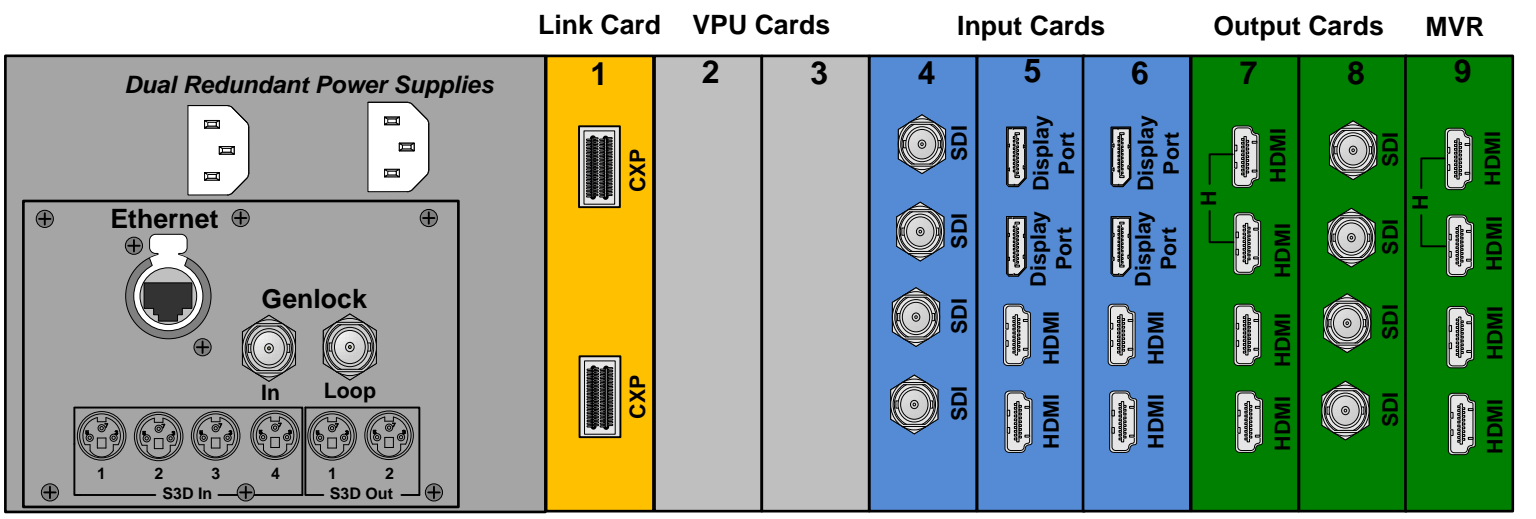

- |   |   |  |
|---|---|--|
| <p><b>SDI Input &amp; Output Cards</b></p> <ul style="list-style-type: none"> <li>- 4 SDI BNC connectors</li> <li>- SD/HD/3G formats (6G ready)</li> </ul> <p><b>DisplayPort/HDMI Combo Input Cards</b></p> <ul style="list-style-type: none"> <li>- 2 DisplayPort and 2 HDMI locking connectors</li> <li>- Displayport 1.1a specification</li> <li>- HDMI 1.4a specification</li> <li>- HDCP 1.4 &amp; EDID 1.3</li> </ul> | <p><b>HDMI Output cards (including MVR)</b></p> <ul style="list-style-type: none"> <li>- 4 HDMI connectors (top 2 connectors capable of single link up to 300MHz)</li> <li>- HDMI 1.4a specification</li> <li>- HDCP 1.4 and EDID 1.3</li> </ul> <p><b>DVI Input &amp; Output Cards (optional)</b></p> <ul style="list-style-type: none"> <li>- 2 DVI-I connectors (no analog signals)</li> <li>- Single / Dual Link formats</li> <li>- DVI 1.0 specification</li> <li>- HDCP 1.4 &amp; EDID 1.3</li> </ul> | <p><b>Link Card</b></p> <ul style="list-style-type: none"> <li>- 2 High speed CXP connectors</li> </ul> <p><b>Notes:</b></p> <ul style="list-style-type: none"> <li>- Each Input and Output card supports one 4K/UHD signal</li> <li>- <b>The cards are NOT hot-swappable</b></li> </ul> |
|---|---|--|

# Event Master Control Software Flowchart

## CONFIGURATION MENU

**C1: Discovery** - When the Event Master control software loads, it automatically discovers the devices connected to the network. These devices are listed on the left hand side of the configuration screen.

**C2: Connect** - Click on the device you want to connect and drag it in the middle area. The software should automatically establish communication with the unit. If connection between the PC and the S3-4K is not achieved, re-check the wire connection. On the Configuration Menu, ensure that the IP settings match with the S3-4K settings that are available from the front panel. You can also connect to the S3-4K by typing the IP address manually.

**C3: System Parameters** - Select the desired Native Rate, Layer and Genlock modes

**C4: Add Backgrounds** - Select and define input connectors as a background. Select the Adjust tab and perform any additional adjustments. Repeat for all Backgrounds and save. Max of 4 connectors of the same type can be assigned per background (Except for DVI & HDMI).

**C5: Add Inputs** - Select and define input connectors as Inputs. Select the Adjust tab and perform any additional adjustments. Repeat for all Inputs and save. Max. of 4 connectors of the same type can be assigned per input. (Except for DVI & HDMI)

**C6: Add Outputs** - Select and define output connectors as Outputs. Select the Adjust tab and perform any necessary adjustments. Repeat for all Outputs and save. Max. of 4 connectors of the same type can be assigned per output.

**Output Test Patterns (Optional)** - Under the Adjust and Output tabs select the test patterns on one or more outputs, to assist with external device setup

**C7: Add Multiviewer Outputs** - Select connectors from the MVR slot and define them as a MVR Output. Repeat for all Outputs and save.

**C8: Add Screen Destinations** - Select the corresponding output connector(s) from the same card and add them to Screen Destinations via drag and drop. From the Adjust tab, add the number of desired layers and perform any necessary adjustments. Repeat for all Screen Destinations and save.

**C9: Add Aux Destinations** - Select the corresponding output connector(s) from the same card and add them to Aux Destinations. Select the Adjust tab and perform any necessary adjustments. Repeat add all Aux Screen Destinations and save.

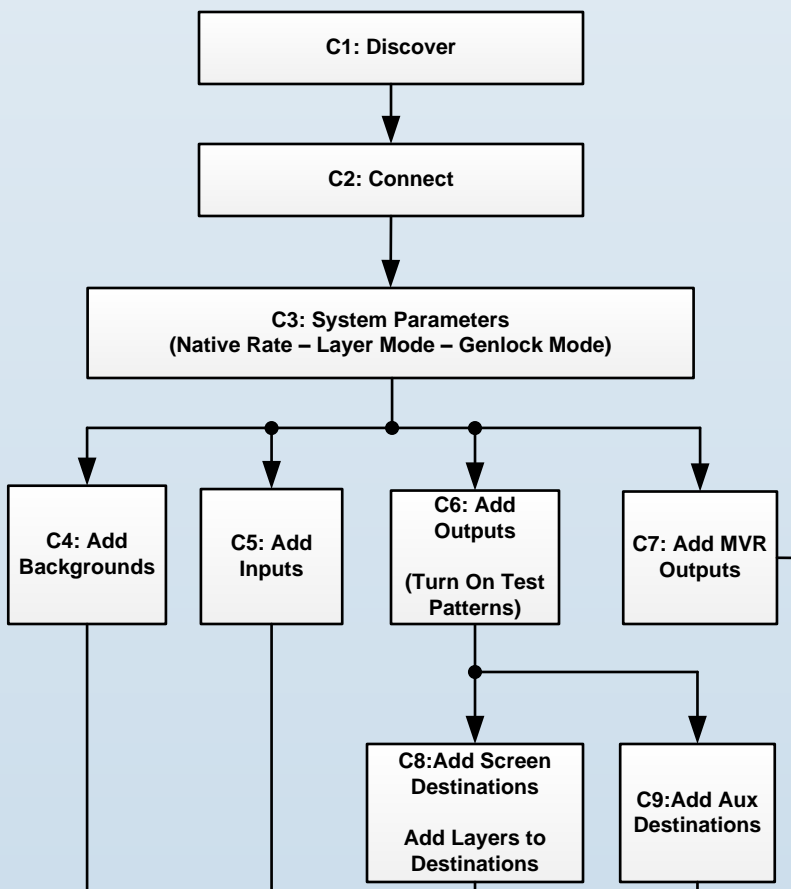

## System Initialization

**Return to Factory Default (Optional)** - For a new event, back up your system if desired, then perform a complete factory reset. For a continuing (or multi-day) event, this step is not required.

**Restoring the System (Optional)** - Insert a USB drive with a previous backup file into the USB Port. On the Backup and Restore Menu, press {Restore System} and follow the prompts.

**Backing up the System (Optional)** - Insert a USB drive into the USB Port. On the Backup and Restore Menu, press {Backup System} to back up the system setup and all memory registers.

**Factory Reset, System Backup and Restore** - operations can be performed from the Events Master Control software or from the front panel.

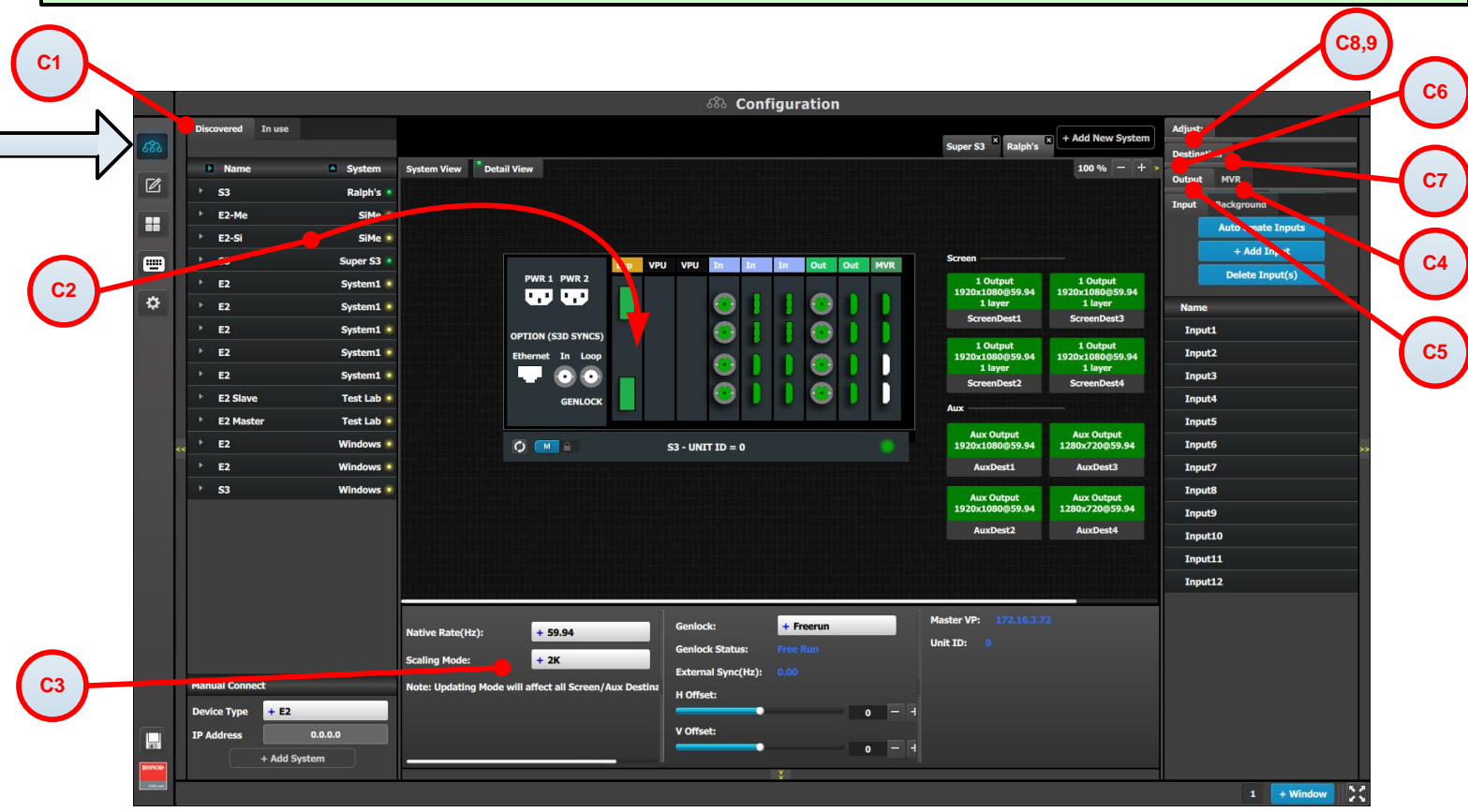

## PROGRAMMING MENU

**P1: Select thumbnails for Backgrounds** - Select the thumbnails to represent the Backgrounds.

**P2: Select thumbnails for Inputs & Stills** - Select the thumbnails to represent Inputs and Stills

**P3: Create Sources** - Under the Input tab create any additional sources (optional). Select the Adjust tab and perform any additional adjustments. Repeat for all Inputs/Sources and save.

**P4: Drop Backgrounds into Screen Destinations** - Under the Background tab select a Background and drop it to a Screen Destinations. Repeat for all Backgrounds and save.

**P5: Drop Layers & Sources** - Under the Layer tab select a layer and drop it to a Screen Destination. Select a Source under the Input tab and drop it into the layer. Alternatively, select a source and drag it to the destination to automatically show the layer with the selected source. Select the Adjust tab and perform any additional adjustments. Repeat for all layers and sources and save.

**P6: Drop Inputs \ Backgrounds to Aux Destinations** - Under the Input or Background tabs select a Input \ Background and drop it to the Aux Destinations. Select the Adjust tab and perform any additional adjustments. Repeat for all Backgrounds and save.

**P7: User Keys** - Select a layer and under Adjust and User Keys tabs click on the Enables to save. Repeat for all Layers and save.

**P8: Presets** - Select Screen(s) and under Adjust and Preset tabs create a new preset or manage existing ones. Repeat to create multiple Presets.

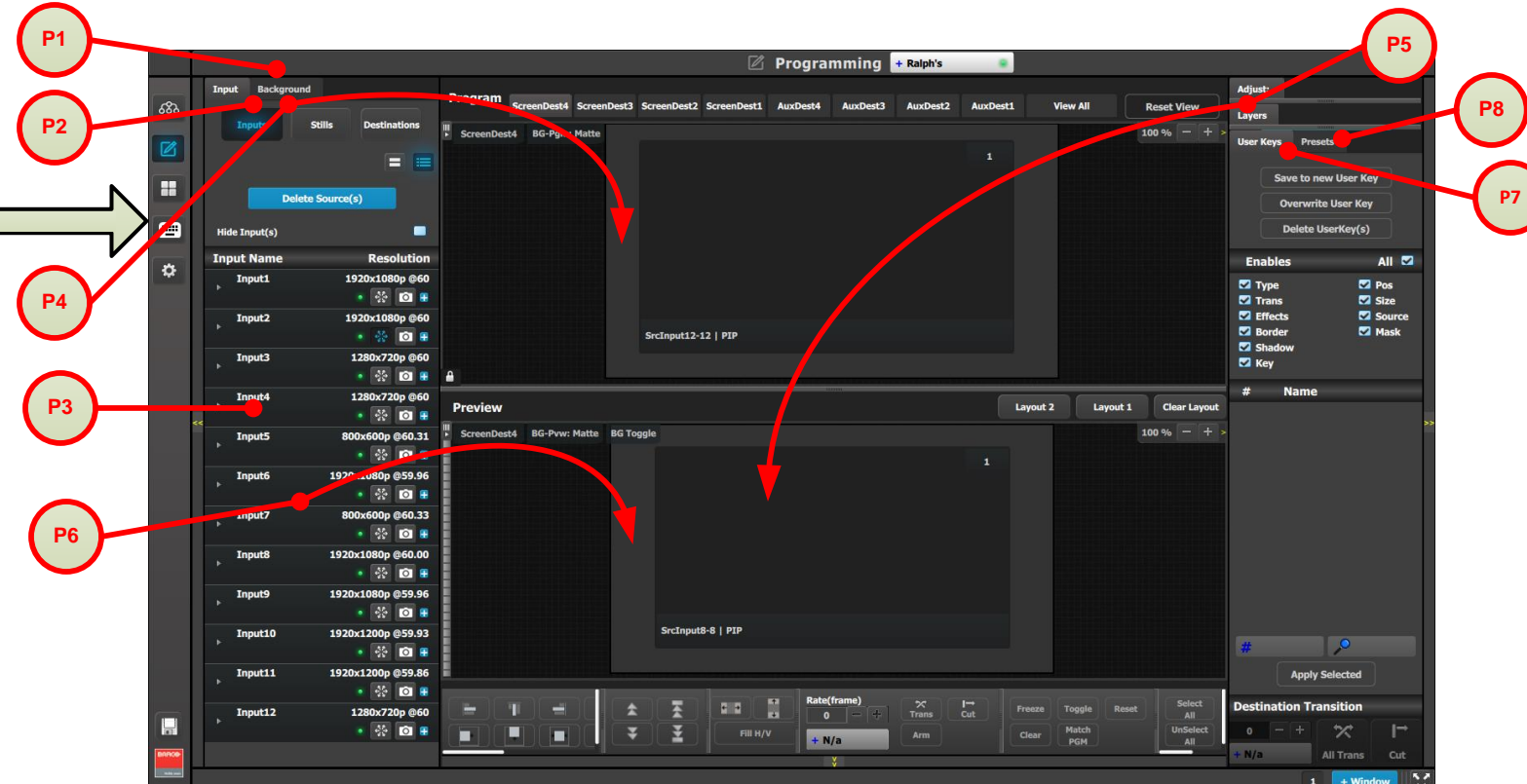
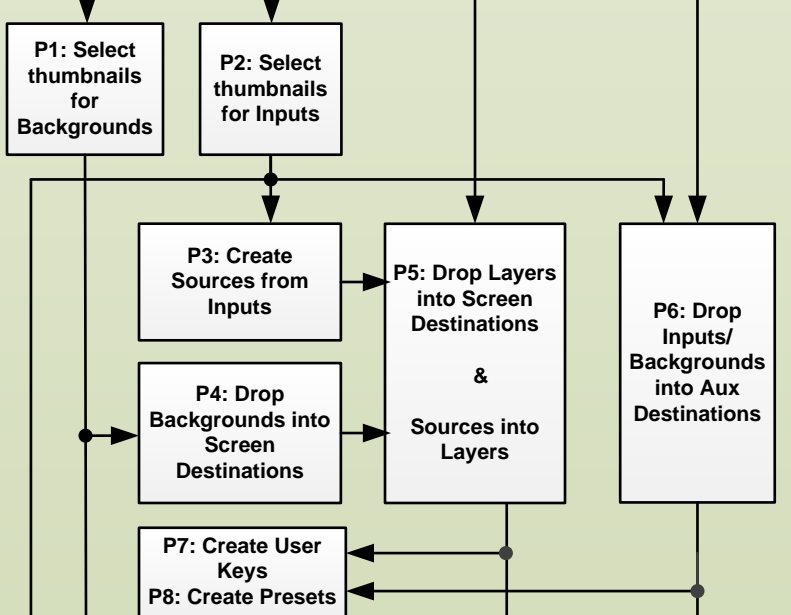

Refer to the User's Guide for a detailed description of each step

Multiviewer Menu (next page)